



finder[®]
SWITCH TO THE FUTURE

RB
SERIES

Bistable relay 8 A



Power
Plants



Panels for
electrical
distribution



Control
panels



Automatic
warehouses

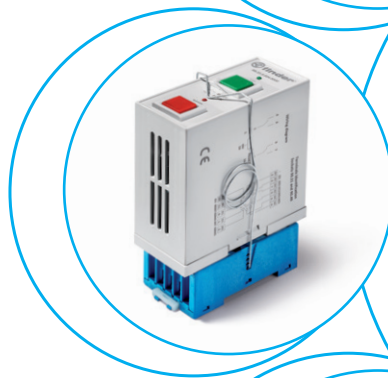



FINDER reserves the right to alter characteristics at any time without notice. FINDER assumes no liability for damage to persons or property, caused as a result of the incorrect use or application of its products.

Bistable relay for control and signaling
RB.14 35 mm rail (EN 60715) mount
RB.22 11 pin socket type 90.21 mount

- 2 or 4 pole changeover contact
- DC voltage
- 2 coil type
- SET and RESET signals
- LED command status indication
- Cadmium Free contact material

RB.14/22
Screw terminal



RB.14

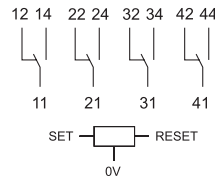

RB.22

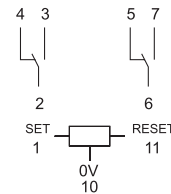

For outline drawings see page 7

Contact specification			
Contact configuration		4 CO (4PDT)	2 CO (DPDT)
Rated current/Maximum peak current	A	8/15	8/15
Rated voltage/ Maximum switching voltage	V AC	250/400	250/400
Rated load AC1	VA	2000	2000
Rated load AC15	VA	350	350
Single phase motor rating (230 V AC)	kW	0.37	0.37
Breaking capacity DC1: 30/110/220 V	A	8/0.3/0.12	8/0.3/0.12
Minimum switching load	mW (V/mA)	300 (5/5)	300 (5/5)
Standard contact material		AgSnO ₂	AgSnO ₂
Coil specification			
Nominal voltage (U _N)	V DC	24 - 48 - 110...125 - 220...250	24 - 110...125 - 220...250
Rated power DC	W	7	4
Operating range	V DC	(0.8...1.1)U _N	(0.8...1.1)U _N
Technical data			
Mechanical life DC	cycles	2 · 10 ⁶	2 · 10 ⁶
Electrical life at rated load AC1	cycles	100 · 10 ³	100 · 10 ³
Operate/release time SET/RESET	ms	10/5	10/5
Insulation between coil and contacts (1.2/50 μs)	kV	6 (8 mm)	4 (8 mm)
Dielectric strength between open contacts	V AC	1000	1000
Ambient temperature range	°C	-40...+55	-40...+55
Protection category		IP 20	IP 20
Approvals relay (according to type)		CE EAC	

Ordering information

Example: RB series, bistable relay, 4 CO, 125 V DC coil, 35 mm rail (EN 60715) mount.

A

R B . 1 4 . 9 . 1 2 5 . 0 0 0 0

Series ————

Type
1 = Modular version

No. of poles
4 = 4 CO

Coil version
9 = DC

Coil voltage
024 = 24 V DC
048 = 48 V DC
125 = 110...125 V DC
250 = 220...250 V DC

Options
0000 = Modular version 35 mm rail (EN 60715)

Codes/supply voltages
RB.14.9.024.0000
RB.14.9.048.0000
RB.14.9.125.0000
RB.14.9.250.0000

Example: RB series, bistable relay, 2 CO, 125 V DC coil, 11 pin socket type 90.21 mount.

R B . 2 2 . 9 . 1 2 5 . 9 0 2 1

Series ————

Type
2 = 11 pin socket type 90.21 mount

No. of poles
2 = 2 CO

Coil version
9 = DC

Coil voltage
024 = 24 V DC
125 = 110...125 V DC
250 = 220...250 V DC

Options
9021 = Version plug-in 90.21 socket
0000 = Version relay only

Codes/supply voltages
RB.22.9.024.0000
RB.22.9.024.9021
RB.22.9.125.0000
RB.22.9.125.9021
RB.22.9.250.0000
RB.22.9.250.9021

Technical data

Insulation according to EN 61810-1

		2 CO	4 CO
Nominal voltage of supply system	V AC	230/400	230/400
Rated insulation voltage	V AC	250	250
Pollution degree		2	2

Insulation between coil and contact set

Type of insulation		Reinforced (8 mm)	Reinforced (8 mm)
Overvoltage category		III	III
Rated impulse voltage	kV (1.2/50 μs)	4	6
Dielectric strength	V AC	2000	3000

Insulation between adjacent contacts

Type of insulation		Basic	Basic
Overvoltage category		III	III
Rated impulse voltage	kV (1.2/50 μs)	4	4
Dielectric strength	V AC	2000	2500

Insulation between open contacts

Type of disconnection		Micro-disconnection	Micro-disconnection
Dielectric strength	V AC/kV (1.2/50 μs)	1000/1.5	1000/1.5

Insulation between coil terminals

Rated impulse voltage (surge) differential mode (according to EN 61000-4-5)	kV(1.2/50 μs)	2
-----------------------------------------------------------------------------	---------------	---

Other data

Bounce time: SET (NO) / RESET (NC)	ms	3/6
Vibration resistance (5...55)Hz: NO/NC	g	3/6
Shock resistance	g	15
Max cable length for push-button connection	m	100

Terminals

		Screw terminal
		Solid and stranded cable
Max. wire size	mm ²	1 x 2.5 / 2 x 1.5
	AWG	1 x 14 / 2 x 16

Contact specification

RB - Maximum DC1 breaking capacity

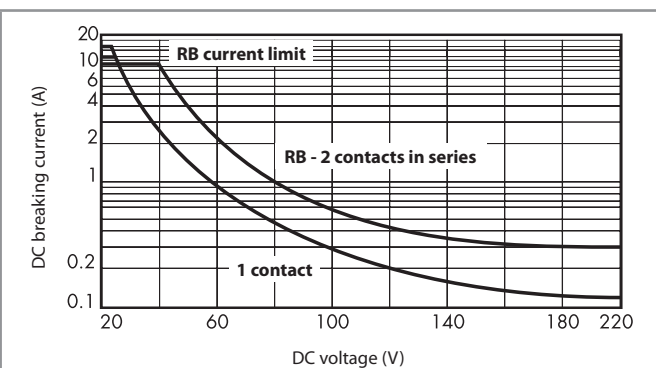

- When switching a resistive load (DC1) having voltage and current values under the curve, an electrical life of $\geq 100 \cdot 10^3$ can be expected.
- In the case of DC13 loads, the connection of a diode in parallel with the load will permit a similar electrical life as for a DC1 load.
Note: the release time for the load will be increased.

XI-2018, www.finder.cn.com

Coil specifications - Type RB.14

DC coil data

Nominal voltage U_N V	Coil code	Operating range		Rated coil consumption I at U_N mA	Rated power W
		U_{min} V	U_{max} V		
24	9.024	19.2	26.4	290	7
48	9.048	38.4	52.8	150	7
110...125	9.125	88	137.5	60	7
220...250	9.250	176	275	30	7

Coil specifications - Type RB.22

DC coil data

Nominal voltage U_N V	Coil code	Operating range		Rated coil consumption I at U_N mA	Rated power W
		U_{min} V	U_{max} V		
24	9.024	19.2	26.4	170	4
110...125	9.125	88	137.5	35	4
220...250	9.250	176	275	18	4

A

Wiring diagrams

A

Type RB.14

Connection for only local push-buttons enable
EN = Enable - Positive voltage
0V = Negative voltage

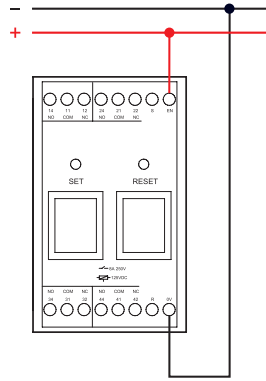

Type RB.14

Connection for remote push-buttons enable

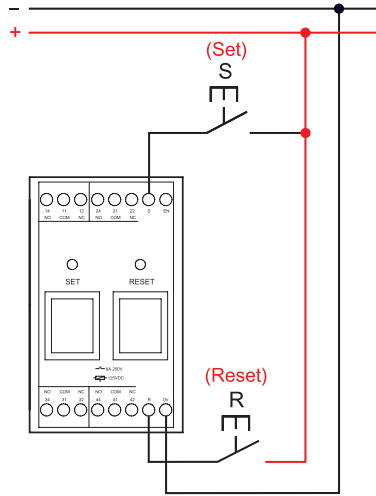

Type RB.14

Connection for local and remote push-buttons enable

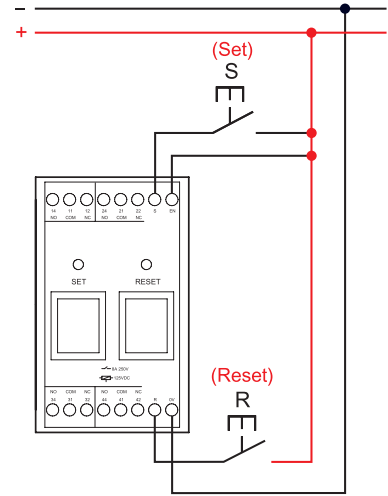

Type RB.22

Connection for only local push-buttons enable
EN = Enable - Positive voltage
0V = Negative voltage

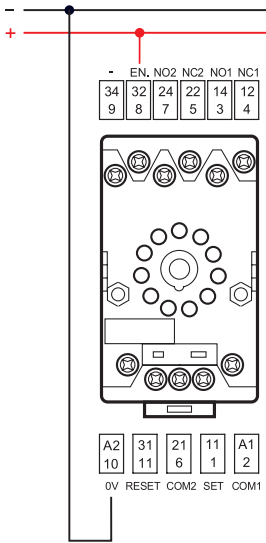

Type RB.22

Connection for remote push-buttons enable

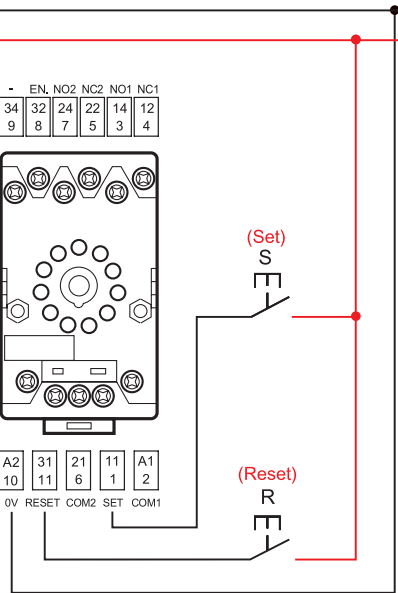

Type RB.22

Connection for local and remote push-buttons enable

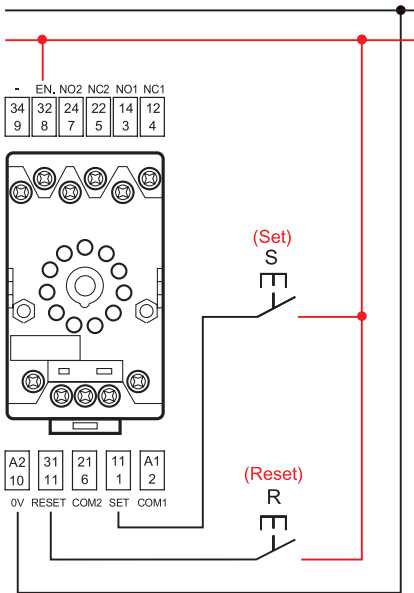

Functions

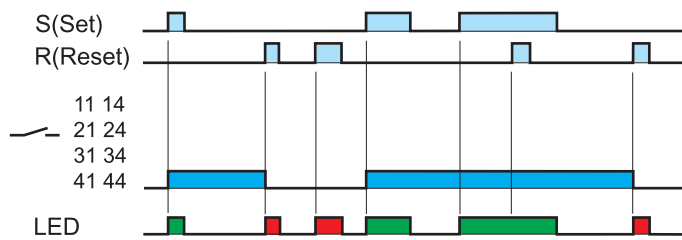

Outline drawing

Type RB.14
Screw terminal

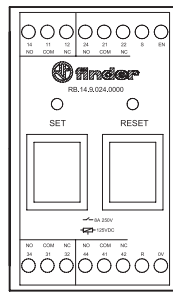
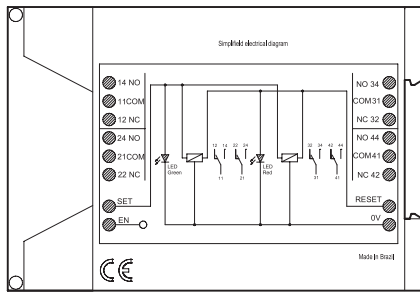
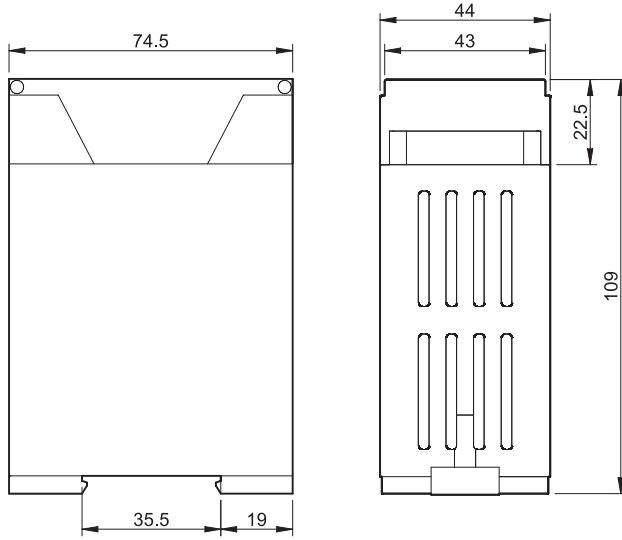

Type RB.22
Screw terminal

