

Fast relay module 8 A



Power
Plants



Panels for
electrical
distribution



Control
panels



Control and
management
of electric
power

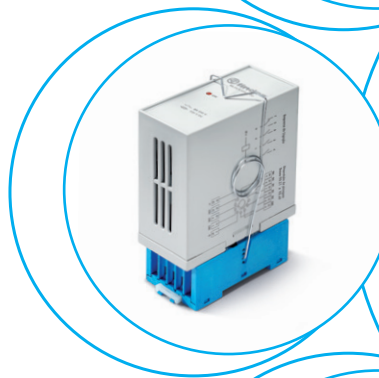



FINDER reserves the right to alter characteristics at any time without notice. FINDER assumes no liability for damage to persons or property, caused as a result of the incorrect use or application of its products.

Fast relay module

RR.14 35 mm rail (EN 60715) mount
RR.24 11 pin socket type 90.21 mount

- 4 pole changeover or 3 NO + 1 changeover contacts
- DC voltage
- Operate time ≤ 3 ms
- LED command status indication
- 35 mm rail (EN 60715) mount
- 11 pin socket type 90.21 mount

RR.14/24
Screw terminal



RR.14

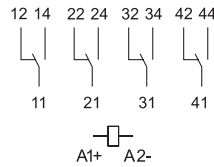

RR.24

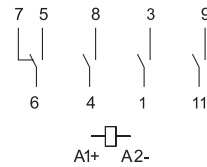

For outline drawings see page 7

Contact specification			
Contact configuration		4 CO (4PDT)	3 NO (SPST-NO) + 1 CO (SPDT)
Rated current/Maximum peak current	A	8/15	8/15
Rated voltage/ Maximum switching voltage	V AC	250/400	250/400
Rated load AC1	VA	2000	2000
Rated load AC15	VA	400	400
Single phase motor rating (230 V AC)	kW	0.3	0.3
Breaking capacity DC1: 30/110/220 V	A	8/0.3/0.12	8/0.3/0.12
Minimum switching load	mW (V/mA)	300 (5/5)	300 (5/5)
Standard contact material		AgCdO	AgCdO
Coil specification			
Nominal voltage (U_N)	V DC	24 - 48 - 110...125 - 220...250	24 - 110...125 - 220...250
Rated power DC	W	< 5	< 3
Operating range	V DC	(0.8...1.1) U_N	(0.8...1.1) U_N
Technical data			
Mechanical life DC	cycles	$10 \cdot 10^6$	$10 \cdot 10^6$
Electrical life at rated load AC1	cycles	$100 \cdot 10^3$	$100 \cdot 10^3$
Operate/release time	ms	2.9/2.5	3/5
Insulation between coil and contacts (1.2/50 μ s)	kV	6 (8 mm)	4 (8 mm)
Dielectric strength between open contacts	V AC	1000	1000
Ambient temperature range	$^{\circ}$ C	-40...+55	-40...+55
Protection category		IP 20	IP 20
Approvals relay (according to type)		CE EAC	

Ordering information

Example: RR series, fast relay module, 4 CO, 125 V DC coil, 35 mm rail (EN 60715) mount.

A

RR.14.9.125.0000

Series
Type
1 = Modular version
No. of poles
4 = 4 CO
Coil version
9 = DC

Coil voltage
024 = 24 V DC
048 = 48 V DC
125 = 110...125 V DC
220 = 220 V DC
250 = 250 V DC

Options
0000 = Modular version 35 mm rail (EN 60715)

Codes/supply voltages
RR.14.9.024.0000
RR.14.9.048.0000
RR.14.9.125.0000
RR.14.9.220.0000
RR.14.9.250.0000

Example: RR series, fast relay module, 3 NO + 1 CO, 125 V DC coil, 11 pin socket type 90.21 mount.

RR.24.9.125.9021

Series
Type
2 = Plug-in version
No. of poles
4 = 3 NO + 1 CO
Coil version
9 = DC

Coil voltage
024 = 24 V DC
125 = 110...125 V DC
250 = 220...250 V DC

Options
9021 = Relay + 90.21 sockets
0000 = Only Relay

Codes/supply voltages
RR.24.9.024.0000
RR.24.9.024.9021
RR.24.9.125.0000
RR.24.9.125.9021
RR.24.9.250.0000
RR.24.9.250.9021

Technical data

Insulation according to EN 61810-1		RR.14	RR.24
		4 CO	3 NO + 1 CO
Nominal voltage of supply system	V AC	230/400	230/400
Rated insulation voltage	V AC	250	250
Pollution degree		2	2
Insulation between coil and contact set			
Type of insulation		Reinforced (8 mm)	Reinforced (8 mm)
Overvoltage category		III	III
Rated impulse voltage	kV (1.2/50 µs)	6	4
Dielectric strength	V AC	3500	2000
Insulation between adjacent contacts			
Type of insulation		Basic	Basic
Overvoltage category		II	II
Rated impulse voltage	kV (1.2/50 µs)	2.5	2.5
Dielectric strength	V AC	2000	2000
Insulation between open contacts			
Type of disconnection		Micro-disconnection	Micro-disconnection
Dielectric strength	V AC/kV (1.2/50 µs)	1000/1.5	1000/1.5
Insulation between coil terminals			
Rated impulse voltage (surge) differential mode (according to EN 61000-4-5)	kV(1.2/50 µs)	2	
Other data			
Bounce time: NO/NC	ms	1.3/5.1	
Vibration resistance (5...55)Hz: NO/NC	g	15/3	
Shock resistance	g	13	
Terminals		Screw terminal	
		Solid and stranded cable	
Max. wire size	mm ²	1 x 2.5 / 2 x 1.5	
	AWG	1 x 14 / 2 x 16	

Contact specification

RR - Electrical life (AC) v contact current

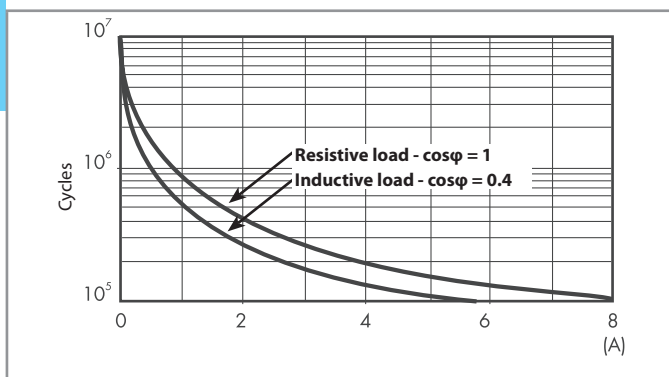

RR - Maximum DC1 breaking capacity

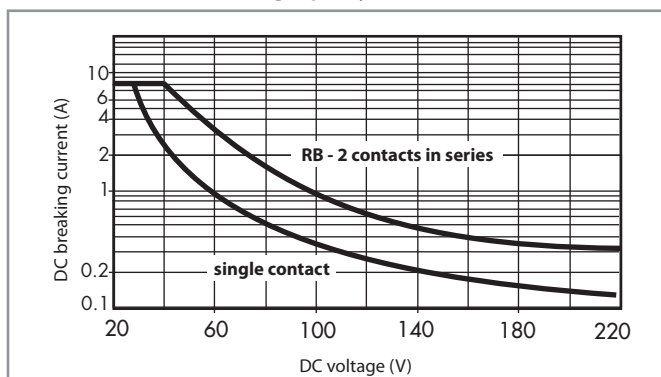

- When switching a resistive load (DC1) having voltage and current values under the curve, an electrical life of $\geq 100 \cdot 10^3$ can be expected.
- In the case of DC13 loads, the connection of a diode in parallel with the load will permit a similar electrical life as for a DC1 load.
Note: the release time for the load will be increased.

Coil specifications - Type RR.14

DC coil data

Nominal voltage	Coil code	Operating range		Holding voltage	Must drop-out voltage	Rated power	Rated coil consumption
		U_{min}	U_{max}				
U_N		V	V	V	V	W	I at U_N
V		V	V	V	V	W	mA
24	9.024	19.2	26.4	15	2.8	4.8	200
48	9.048	38.4	52.8	30	3	3.8	80
110...125	9.125	88	137.5	80	12	3.8	30
220	9.220	176	242	150	20	4.0	18
250	9.250	200	275	160	22	3.8	15

Coil specifications - Type RR.24

DC coil data

Nominal voltage	Coil code	Operating range		Holding voltage	Must drop-out voltage	Rated power	Rated coil consumption
		U_{min}	U_{max}				
U_N		V	V	V	V	W	I at U_N
V		V	V	V	V	W	mA
24	9.024	19.2	26.4	14	2.4	2.9	120
110...125	9.125	88	137.5	80	12	2.5	20
220...250	9.250	176	275	150	20	1.8	8

Outline drawing

Type RR.14
Screw terminal

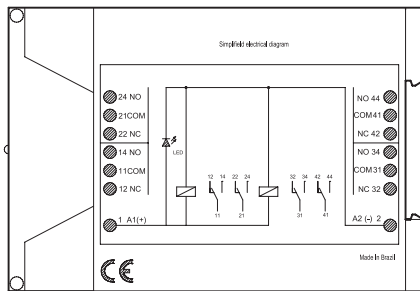
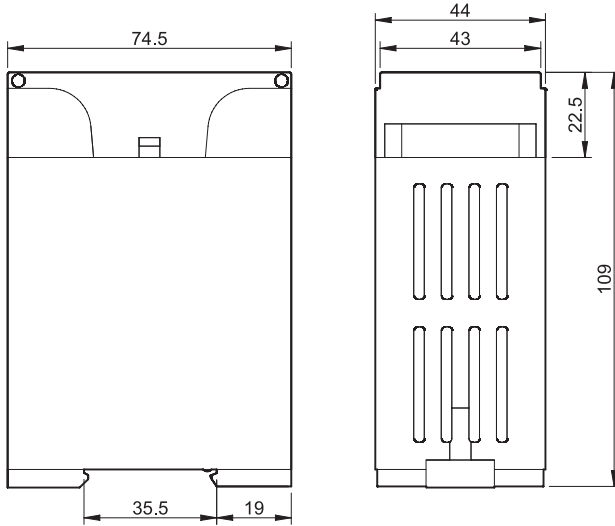

Type RR.24
Screw terminal

